

## **Optimization in Load Flow Analysis of Power System Interconnected System Using Sponge and Aloe Techniques**

Saiyadasad Ali Naqvi<sup>1</sup>, Shuchi Shukla<sup>2</sup>

*Department of Electrical Engineering, Regional College for Education Research and Technology, Jaipur, India  
Er.sanaqvi001*

*Corresponding Author: Saiyadasad Ali Naqvi*

---

**Abstract**— The problem of electrical system optimization has become a decisive factor in the current electrical system engineering practice, which emphasis cost and power loss. In this research financial and electrical loss, dispatch problem has been addressed using three efficient adaptation methods, ant lion optimization (ALO), genetic algorithm (GA) and particle swarm optimization (PSO). The hybrid 3-generator testing system, 30-bus and 6 generator made from these three algorithms have been implemented on the IEEE Test System. The results are compared with the PSO, Genetic Algorithm (GA) and ALO, with respect to three and 6 generator testing systems. This analysis of the three techniques shows that the problem of ELD is the difficulty in its maximum load capacity, where these techniques have been shows analysis.

PSO has been implemented to allocate active power between the generating stations that make up the system's deficiency and reduce the cost of electricity generated. ELD problem is resolved for IEEE 30 bus testing network with 6 generating units using modified particle swarm optimization (MPSO) method. The results using the PSO method are comparable to the genetic algorithm (GA).

**Keywords**— Ant colony search algorithm (ACSA), Evolutionary Computation (EC), Fuzzy Set Theory (FST), Genetic algorithms (GA), Particle swarm optimization (PSO), Simulated Annealing (SA)

---

Date of Submission: 05-05-2018

Date of acceptance: 23-05-2018

---

### **I. Introduction**

Economic Load Transmission (ELD) of the power generation units has always occupied an important place in the power industry. ELD is a computational process where the total generation is distributed among the generation units in operation, subject to the reduction of the selected cost criterion, the weight and the lack of operation. For any specified load position, ELD determines the power output of each plant (and each production unit within the plant), which will reduce the total fuel cost required for the service of the system load. The use of ELD is done by most programs in real time energy management power system control to allocate total units available in the actual units. The focus is on coordinating the production cost on all the power plants operating on the ELD system. In practical power systems, which are able to feed a limited range of demand for electricity, it is very important to optimize the operating costs of generation units from an economic perspective. Therefore, generally economic Dispatch (ED) techniques are used to determine the cost of the least possible generation. Load demand, transmission power loss, power generation limit and generation cost coefficients are parameters which should be kept in mind for any ED technique.

In the last decade, several attempts have been made to solve the problem of ED, which include various types of obstacles through traditional methods like lambda walking method, base point and participatory factor method, shield system, Newton based methodology. Non-linear programming (NLP), Linear programming (LP), Quad programming (QP), Mixed-integer programming (MIP).

In Lambda recurrence and gradient-based methods, the cost work for individual generators is resolved about the equivalent ELD in the context of single-functional function. These techniques require incremental fuel cost reduction, which are linear according to the pieces and the global increases monotonically to find optimal solutions. For generators with incremental cost reduction with non-monotonically, conventional methods have either ignored or separated segments of increasing cost curve, which are not continuous or are increasing in non-tonic form.

These limitations of modern methods include modern meta-generational changes such as the Artificial Neural Network (ANN), Genetic Algorithms (GA), Tabu Search (TS), Simulation Annealing (SA), Particle Swarm Adaptation (PSO), Ant Colony Optimization (Modern Neural Network) Attractive ACOs), Artificial Immune System (AIS), Differential Development (DE), Bacterial Forging Algorithms (BFA), Artificial Bee Colony (ABC) algorithms. Although these methods are not able to obtain the best optimum solution for ELD problems, although they are largely produced near the optimum solution.

## II. Economic Load Dispatch Problem With Loss

The power system, the losses of transmission can sometimes be ignore due to the distance of transmission is short and the generators are not located at the area which far from the load center. However, if the generators are far from then load center, then it has to consider that transmission losses as an important factor as this may take a significant effect on the dispatch system. The transmission losses can be represented in the form of quadratic function which is shown below [28],

$$P_L = \sum_{i=1}^n \sum_{j=1}^n P_i B_{ij} P_j \quad (1)$$

$B_{ij}$  is the loss coefficients or B-coefficients.

However, PL also can be represented in Kroon's loss formula,

$$P_L = \sum_{i=1}^n \sum_{j=1}^n P_i B_{ij} P_j + \sum_{i=1}^n B_{0i} P_i + B_{00} \quad (2)$$

And the energy balance is represented as equation 1.4

$$\sum_{i=1}^n P_i = P_D + P_L \quad (3)$$

Where we consider the constraint of generators power limits [28]

$$P_i, \min \leq P_i \leq P_i, \max \quad i = 1, \dots, n \quad (4)$$

Cost function in equation 3.1

$$C_t = \sum_{i=1}^n \alpha_i + \beta_i P_i + \gamma_i P_i^2 \quad (5)$$

By using the Lagrange multiplier

$$L = C_t + \lambda(P_D + P_L - \sum_{i=1}^n P_i) \quad (6)$$

As the minimum of the unconstraint function can be located at the point where the partials of the function are equal to zero.

$$\frac{\partial L}{\partial P_i} = 0 \quad (7)$$

$$\frac{\partial L}{\partial \lambda} = 0 \quad (8)$$

Then,

$$0 = \frac{\partial C_t}{\partial P_i} + \lambda \left( 0 + \frac{\partial C_t}{\partial P_i} - 1 \right) \quad (9)$$

If,

$$C_t = C_1 C_2 + \dots + C_n \quad (10)$$

Thus,

$$\frac{\partial C_t}{\partial P_i} = \frac{dC_i}{dP_i} \quad (11)$$

Then, the condition for optimum dispatch is

$$\frac{dC_i}{dP_i} + \lambda \left( \frac{\partial P_L}{\partial P_i} \right) = \lambda \quad (12)$$

Rearranged the equation we will obtain,

$$\left( \frac{1}{1 - \frac{\partial P_L}{\partial P_i}} \right) \frac{dC_i}{dP_i} = \lambda \quad (13)$$

$$\frac{\partial PL}{\partial Pi} = \text{incremental transmission loss.}$$

$$L_i = \left( \frac{1}{1 - \frac{\partial P_L}{\partial P_i}} \right) \quad (14)$$

Or,

$$L_i = \left( \frac{dC_i}{dP_i} \right) = \lambda \quad (15)$$

$L_i$  = penalty factor of generator  $i$ th

According to the equation 1.31,

$$\frac{\partial P_L}{\partial P_i} = 2 \sum_{j=1}^n B_{ij} P_j + B_{0i} \quad (16)$$

From equation 3.31, the incremental cost equation is

$$\frac{dC_i}{dP_i} = 2\gamma_i P_i + \beta_i \quad (17)$$

By substituting equation 3.36 and 3.37 into equation 3.32,

$$2\gamma_i P_i + \beta_i + \lambda \left( \sum_{j=1}^n B_{ij} P_j \right) + B_{0i} \lambda = \lambda \quad (18)$$

Or rearranged it in the form of,

$$\left( \frac{\gamma_i}{\lambda} + B_{ii} \right) P_i + \sum_{j=1, j \neq i}^n B_{ij} P_j = \frac{1}{2} \left( 1 + B_{0i} - \frac{\beta_i}{\lambda} \right) \quad (19)$$

Equation 3.39 will be converted into the form of  $P_i$  at the  $k$ th iteration,

$$P_i^{(k)} = \frac{\lambda^k (1 - B_{0i}) - \beta_i - 2\lambda^{(k)} \sum_{j \neq i}^n B_{ij} P_j^{(k)}}{2(\gamma_i + \lambda^{(k)} B_{ii})} \quad (20)$$

Substitute equation 20 into equation 1.4,

$$\sum_{i=1}^n \frac{\lambda^{k(1-B_{0i})-\beta_i-2\lambda^{(k)} \sum_{j \neq 1}^n B_{ij} P_j^{(k)}}}{2(\gamma_i + \lambda^{(k)} B_{ii})} = P_D + P_L^{(k)} \quad (21)$$

Or,

$$f(\lambda)^{(k)} = P_D + P_L^{(k)} \quad (22)$$

By using the Taylor's series and ignore the higher order of the terms,

$$f(\lambda)^{(k)} + \left(\frac{df(\lambda)}{d\lambda}\right)^{(k)} \Delta\lambda^{(k)} = P_D + P_L^{(k)} \quad (23)$$

Then,

$$\Delta\lambda^{(k)} = \frac{\Delta P^{(k)}}{\left(\frac{df(\lambda)}{d\lambda}\right)^{(k)}} \quad (24)$$

Where,

$$\left(\frac{df(\lambda)}{d\lambda}\right)^{(k)} = \sum_{i=1}^n \frac{dP_i^{(k)}}{d\lambda} \quad (25)$$

And,

$$\sum_{i=1}^n \left(\frac{\partial P_i}{\partial \lambda}\right)^{(k)} = \sum_{i=1}^n \frac{\gamma_i(1-B_{0i})+B_{ii}\beta_i-2\gamma_i \sum_{j \neq 1}^n B_{ij} P_j^{(k)}}{2(\gamma_i + \lambda^{(k)} B_{ii})^2} \quad (26)$$

Thus,

$$\lambda^{(k+1)} = \lambda^{(k)} + \Delta\lambda^{(k)} \quad (27)$$

Where,

$$\Delta P^{(k)} = P_D + P_L - \sum_{i=1}^n P_i^{(k)} \quad (28)$$

The iteration process will be continued until is out of the specified accuracy,

$$P_L = \sum_{i=1}^n B_{ii} P_i^2 \quad (29)$$

If,  $B_{ij} = 0$  and  $B_{00} = 0$ , the equation 3.40 can be expressed as

$$P_i^{(k)} = \frac{\lambda^{(k)} - \beta_i}{2(\gamma_i + \lambda^{(k)} B_{ii})} \quad (30)$$

By substituting equation 3.40 into equation 3.46, we will get

$$\sum_{i=1}^n \left(\frac{\partial P_i}{\partial \lambda}\right)^{(k)} = \sum_{i=1}^n \frac{\gamma_i + B_{ii}\beta_i}{2(\gamma_i + \lambda^{(k)} B_{ii})^2} \quad (31)$$

### III. Optimization Techniques

There are many optimization techniques used to minimize the operating cost of the system among which these techniques are used to compare the results on three six and nine generator system i.e. PSO, GA, ALO.

Nowadays, economic dispatch problem was solved by programming techniques such as genetic algorithm, particle swarm optimization and others dynamic programming methods. Economic problem in practical system have equality and inequality constraints, so it is hard to be solved by conventional mathematical method. However, PSO has been treated as one of the most powerful solution that is able to be applied to the practical problem.

Previously, by using conventional method Lambda Iteration was not capable to solve the ED problem effectively and will take longer time to solve. Thus, new method such as PSO was being introduced by researchers in solving various kinds of problem such as image and video analysis, electronics and electromagnetics, antenna design, economic load dispatch, finance and economics and etc.

#### Particle Swarm Optimization

PSO method was invented by Kennedy and Beernaert in the year of 1995. PSO is a modern method used to solve the economic dispatch problem which is whether linear or non-linear.

PSO approach was inspired by the nature of swarm of bird and school of fish. In the swarm of bird, each of them will have its own decision based on its experience and other bird experiences. In PSO, there are particles which are situated in a search space. Every particle is represented by 2 vectors which are position,  $P_i$ , velocity  $V_i$ . The equation of the PSO velocity and position of particle were shown below,

$$V_i^{(r+1)} = wV_i^{(r)} + C_1R_1(Pb_i^r - P_i^{(r)}) + C_2R_2(G_i^r - P_i^{(r)}) \quad (32)$$

$$P_i^{(r+1)} = P_i^{(r)} + V_i^{(r+1)} \quad (33)$$

$V_i$  is the velocity of  $i$ th particle at  $r$ th iteration

$$V_i \min \leq V_i(r) \leq V_i \max$$

$P_i$  is the current position of  $i$ th particle at  $r$ th iteration.  $w$  is the weighing function or inertia weight factor.  $C_1$  and  $C_2$  are the acceleration constant, normally is 2.  $R_1$  and  $R_2$  is the random number between 0 and 1

Every particle will refer the current of the best value of the position of other particles and track the best one in order to regulate the movement of its own the search space. Iteration process keep going in order to get

the optimum of the fitness function like the swarm of birds which finding the only food in the search space when there is only one food.

Assume that every position of the particle is the solution to the problem, then the best position will be stored as the P best which is considered to be the best value for next iteration. Thus the value will be updated by using the formula,

$$P_i^{new} = P_i^{(r)} + P_i^{new} \quad (34)$$

While the new velocity and position is

$$V_i^{new} = wV_i^{(r)} + C_1R_1(P_i^{best} - P_i^{(r)}) + C_2R_2(G_i^{best} - P_i^{(r)}) \quad (35)$$

For the weight factor or inertial weight it can be represented as

$$W = W_{max} - \frac{W_{max} - W_{min}}{IT_{max}}(IT) \quad (36)$$

Where,

ITmaxis the maximum number of iterations IT is the current number of iterations

The weight factor or inertial weight actually is very crucial in better manipulation of the stability of the function. Researchers have concluded that the larger value of the weight factor at the first setting will give the most accurate result and then slowly reduce the value of weight factor to a smaller value. Proper weight factor is able to reduce the number of iteration in searching of solution. However, the best value of weight factor is related to the values of C1 and C2, the acceleration constant. Therefore, weight factor, w and acceleration factor C2 are quite important in maintaining the stability of the PSO. This is due to acceleration factor play the role in attracting particles toward the P best and G best.

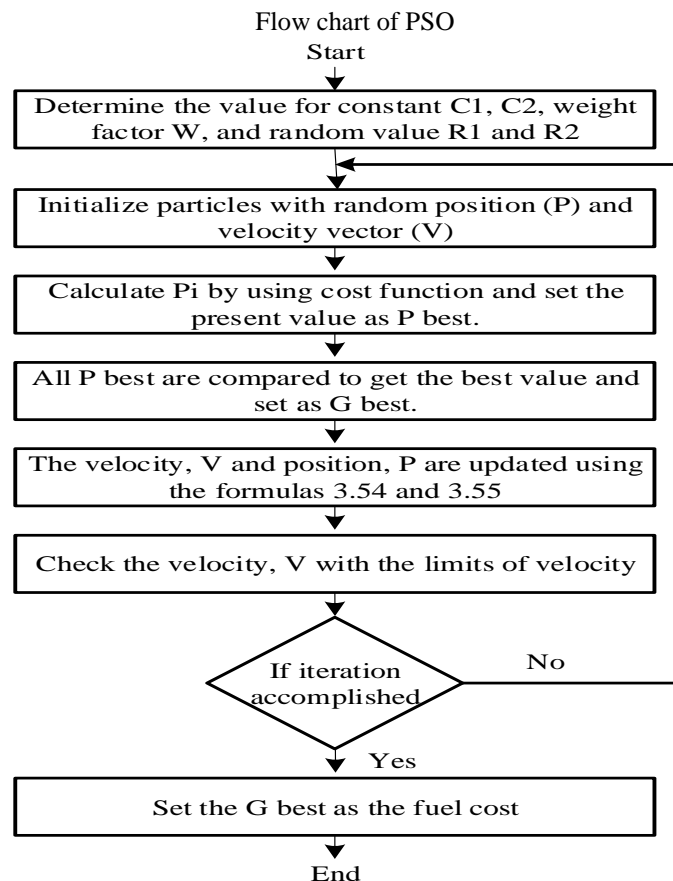

Fig. 1 Flow chart of PSO

### Genetic Algorithm

GA is a mechanical-based search algorithm of Natural Selection and Natural Genetics; They combine Darwin's theory with 'Surviving of the Fittest', with a structured yet random information exchange with string structures, a search with some innovative nature of human discovery To create algorithm. In every generation, a new set of artificial creatures (strings) is made using bits and pieces of old people; an occasional

new part is tried well, even though random, genetic algorithms are not easy moving algorithms. They take advantage of historical information to predict on new search points with better performance of the candidate.

Individuals in the population are known through the process of development. The advantages of the genetic algorithm approach are also discussed in terms of problem reduction, flexibility and solution methodology. Some benefits and disadvantages are discussed with the assumption that are used to solve our problem.

Different steps GA have been explained with the help of simplified flowchart as shown in Fig. 2 below. GA has maintained the set chromosomes stability of the possible solution of problem-solving domains due to work. As an optimization method, they evaluate and manipulate these chromosomes, whose names are genetic operators. During each iteration step, known as a generation, representative chromosomes in the current population are evaluated as optimal solutions for their fitness. By comparing these fitness values, the new population of the solution chromosomes has been created using genetic operators known as breeding, crossover and mutation. There are five components needed to implement genetic algorithm.

The ant lion optimizer, called ALO or the ant lion optimizer, is a recent meta-estimate which mathematically interacts with ants and ant lions in nature. A customizable algorithm has been developed, so that the ant lion can be used for random walking, trapping of traps, trapping ants in the trap, catching pre-falls and reproducing traps.

**Inspiration**

Ant lions are sometimes known as Dudley's bugs, they are under the merckell ant family and live in two stages of larvae and adult. Their lungs are interesting when they have a hunting system. The ants are made to trap ants by trapping them in the form of small cones. Entrees sit under the pit and wait for the victim to get trapped. After consuming the victim's meat, ant lions left the pit and revised the pit for the next victim. It has been observed that ant lions dig a big pit during hunger and it is the main motivation for ALO algorithms.

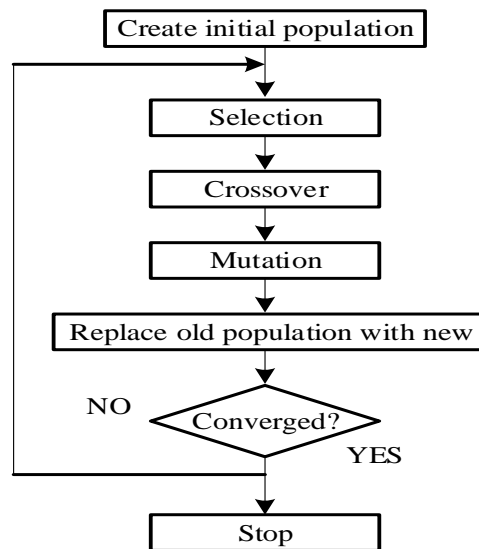

Fig.2. Simplified Flowchart of a Genetic Algorithm

**Ant lion optimizer**

The operator of the ALO algorithm has been described above, the ALO algorithm shows the five main steps of hunting in the larvae: Anatomy involves random walking, net formation, trapping ants in the trap, catching pre-falls, and re-building nets. The following paragraphs and sub-class represent mathematical models: The main random move in this algorithm is as follows:

$$X(t) = [0, cumsum(2r(t_1) - 1), cumsum(2r(t_2) - 1), \dots, cumsum(2r(t_2) - 1), ]$$

$$r(t) = \begin{cases} 1 & rand > 0.5 \\ 0 & rand \leq 0.5 \end{cases} \quad (37)$$

Where the cumulative amount calculated, N is the maximum number of repetitions, T represents the random walking phase (running in this study), R (T) is a rigorous task, T shows the phase of random walking (this Walking in the study) and the rand arises with the same distribution in the interval of a random number [0, 1].

The location of the ants should be stored in the following metrics:

$$M_{Ant} = \begin{bmatrix} A_{1,1} & A_{1,2} & \dots & A_{1,d} \\ A_{2,1} & A_{2,2} & \dots & A_{2,d} \\ \dots & \dots & \dots & \dots \\ A_{n,1} & A_{n,2} & \dots & A_{n,d} \end{bmatrix} \quad (38)$$

Where the matrix protects the position of each ant, the value of the J-th variable of A, J-i-th ant, the number of ants and the number of d variables.

For each ant lion, the respective objective value is calculated and stored in the following matrix:

$$M_{OA} = \begin{bmatrix} f([A_{1,1}, A_{1,2}, \dots, A_{1,d}]) \\ f([A_{2,1}, A_{2,2}, \dots, A_{2,d}]) \\ \dots \\ \dots \\ f([A_{n,1}, A_{n,2}, \dots, A_{n,d}]) \end{bmatrix} \quad (39)$$

Where MOA is the matrix for the protection of each ant's fitness, A, J represents the value of the J-dimension of Ant-J ant, the number is the number of ants, and the F is the objective function. In ALO, it is believed that ant lions hide anywhere in the search field. To protect your position and fitness costs, the following metrics are used:

$$M_{OAL} = \begin{bmatrix} f([AL_{1,1}, AL_{1,2}, \dots, AL_{1,d}]) \\ f([AL_{2,1}, AL_{2,2}, \dots, AL_{2,d}]) \\ \dots \\ \dots \\ f([AL_{n,1}, AL_{n,2}, \dots, AL_{n,d}]) \end{bmatrix} \quad (40)$$

While there is basically the matrix to protect every ant lion's fitness, Eli has come in Jammu, reflecting J-dimension value of the lion, N is the number of ant lions, and F is the objective task.

Random walks of ants

To update the status of random moving ants discussed above, the following equation is used:

$$X_i^t = \frac{(x_i^t - a_i) \times (d_i - c_i^t)}{(d_i^t - a_i)} + c_i \quad (41)$$

Where AE is the minimum of random variables of i-th variable, maximum randomly runs in two horizontal, see math mL source in at least i-th variable in t-th rotation, and see math mL source t-in the second move indicates the maximum i-th variable.

Trapping in ant lion's pits

The effect of the ant lion on the movement of the ants has been done as follows:

$$c_i^t = Antlion_j^t + c^t \quad (42)$$

$$d_i^t = Antlion_j^t + d^t \quad (43)$$

Where CT is the minimum of all the variables on T-DV duplication, the DT indicates the vector, which includes maximum all variables on TV repetition, to see the methari mL source, I-th ant, see Math mL source there is a maximum of all variables for ant lions, and math mL source shows Jay-th chees selected lion on T-th repetition. Building trap

Building mesh done with a roulette wheel. Roulette Wheel operator selects ant lion based on its fitness during adaptation. This mechanism gives fitter ant lion a high likelihood of catching ants.

Sliding ant towards ant lion

The mathematical model of this stage of the hut is given below. It can be seen in the equation that optimization of radius hyper-sphere of ants has decreased.

$$c^t = \frac{c^t}{I} \quad (44)$$

$$d^t = \frac{d^t}{I} \quad (45)$$

Where I have a ratio, whistle is the minimum of all the variables on t-variable repetition, and indicates the DT vector, which includes maximum all variables on T-th intensity.

Catching prey re-building the pit

The catch in prey in ALO occurs when the ants get fitter (dive inside the sand) compared to their respective ant lions. After that, an ant lion needs to update its position in the latest state of the victim's ant, to increase the probability of catching new prey. The following equation simulates this behavior:

$$Antlion_j^t = Ant_i^t \text{ if } f(Ant_i^t) > f(Antlion_j^t) \quad (46)$$

Where t shows current walking, see Math mL source, indicates J-th lion's position on T-th repetition, and see Math mL source T-th shows the position of the ant lion. Elitism

Elitism is an important feature of evolutionary algorithms that allows them to retain the best solution (s) obtained at any stage of the optimization process. In this study, the best ant lion has been saved so far in every leg

and it is considered as an elite class. Because the elite is the most worthy ant lion, it should be able to affect the movements of all ants during iterations. Therefore, it is believed that every ant walks around the chosen Eddie Lion by the Rowlett Wheel and together the elite is as follows:

$$Ant_i^t = \frac{R_A^t + R_E^t}{2} \quad (47)$$

Where an  $R_t$  ruffle wheel runs randomly around an ant lion running in  $T$ -th, where the  $R_t$  runs on  $T$ -th iteration around the elite class, and anti- $i$ -ant ant-position  $t$ -th repetition [6].

Flowchart of ALO

The work of the Ant lion Optimizer gravitational search algorithm is shown in Figure 3.

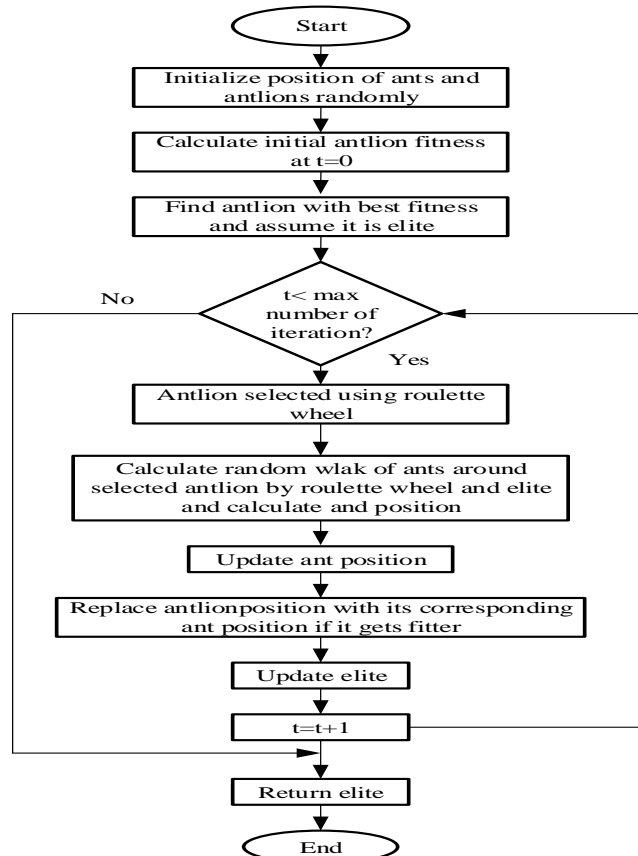

Fig. 3. Flowchart of ALO

#### IV. Generator System

##### A. Three Generator System

The one-line diagram for the 3-Bus system is presented in Figure 4. There are three units in the system. The generator system is referred as IEEE 3-Generator standards. MATLAB/ Simulink model is presented in figure4.2 and all loads are L1, L2 and L3 of 100 MW/35 MVAR, 125 MW/ 50 MVAR and 90 MW / 30 MVAR respectively and the maximum capacitive of generator are 192 MVA, 247.5 MVA and 128 MVA respectively. Dataset for the system are given in appendix A.1. The transmission line and unit parameters are presented in table 1 and table 2, respectively.

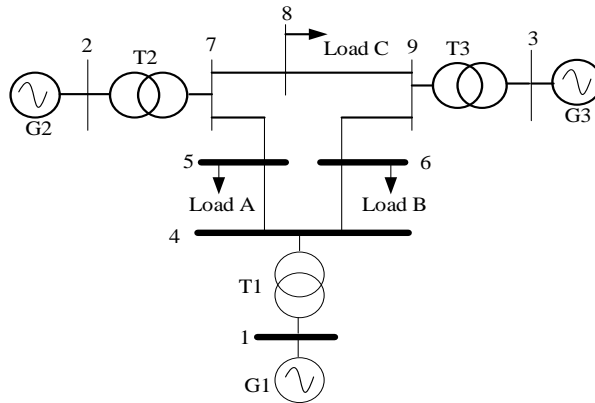

Fig 4: One-line Diagram for 3-Generator System

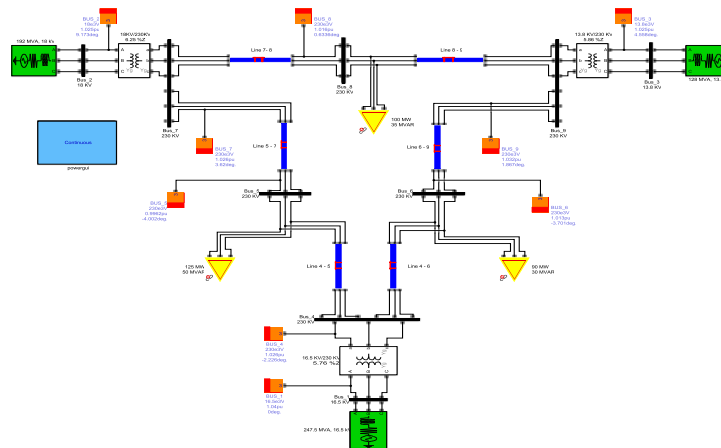

Fig 5: MATLAB/Simulink Diagram for 3-Generator System

Table.1.Specification of three-generator power system

Unit	ai	bi	ci	Pi (min)	Pi (max)
1	0.00525	8.663	328.13	50	250
2	0.00609	10.04	136.91	5	150
3	0.00592	9.76	59.16	15	100

Table.2. the transmission loss coefficients

Unit	Bi1	Bi2	Bi3
1	0.000136	0.0000175	0.000184
2	0.0000175	0.000154	0.000283
3	0.000184	0.000283	0.000161

B. Six Generator System

The 6 generator system is taken from IEEE standard and it is shown in Figure 6. The bus data, line data are given In Table 3 and 4.

Table.3. Specification of six-generator power system

Unit	ai	bi	ci	Pi (min)	Pi (max)
1	0.00375	2	0	50	200
2	0.0175	1.75	0	20	80
3	0.0625	1	0	15	50
4	0.00834	3.25	0	10	35
5	0.025	3	0	10	30
6	0.025	3	0	12	40



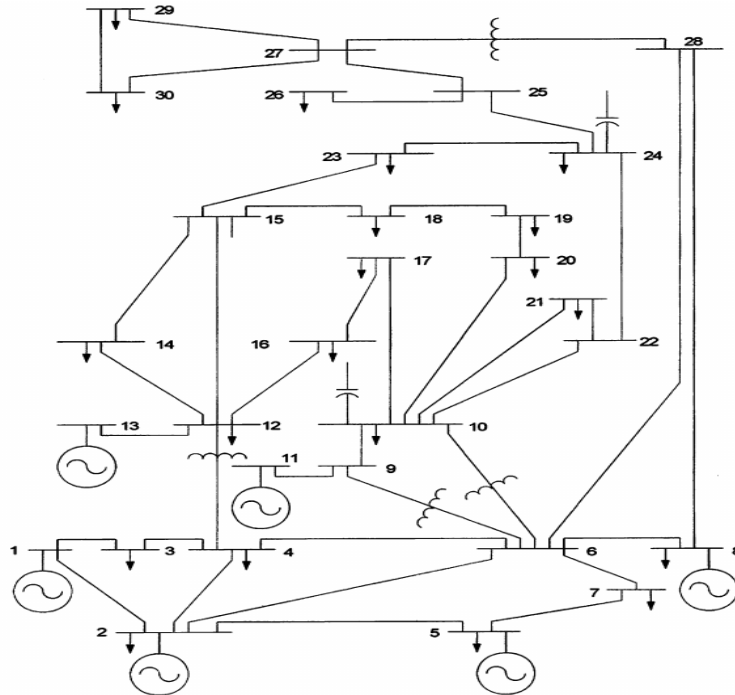

Fig 6 Single-line Diagram for 6-Generator System

Table.4.The transmission loss coefficients

Unit	Bi1	Bi2	Bi3	Bi4	Bi5	Bi6
1	0.000218	0.000103	0.000009	-0.00001	0.000002	0.000027
2	0.000103	0.000181	0.000004	-0.000015	0.000002	0.00003
3	0.000009	0.000004	0.000417	-0.000131	-0.000153	-0.000107
4	-0.00014	-0.000015	-0.000131	0.000221	0.000094	0.00005
5	0.000002	0.000002	-0.000153	0.000094	0.000243	0
6	0.000027	0.00003	-0.000107	0.00005	0	0.000358

CASE STUDY-1: Three Unit System

The fuel cost is in Rs. /h of three thermal plants of a power system are

$$C_1 = 328.13 + 8.663p_1 + 0.00525p_1^2 \text{ Rs./h}$$

$$C_2 = 136.91 + 10.04p_2 + 0.00609p_2^2 \text{ Rs./h}$$

$$C_3 = 59.160 + 9.76p_3 + 0.00592p_3^2 \text{ Rs./h}$$

Where  $P_1, P_2$  and  $P_3$  are in MW. Plants outputs are subject to the following limits

$$50\text{MW} \leq P_1 \leq 250\text{MW}$$

$$5\text{MW} \leq P_2 \leq 150 \text{ MW}$$

$$15\text{MW} \leq P_3 \leq 100 \text{ MW}$$

Total system load is 300MW

ED WITH TRANSMISSION LOSSES

Result through Ant lion Optimization method with transmission losses:

$$P_1 = 202.4705 \text{ MW}$$

$$P_2 = 80.9842 \text{ MW}$$

$$P_3 = 27.0817 \text{ MW}$$

Power Loss = 10.5363 MW

Total generation cost = 3615.10 Rs/h

Result through GA method with transmission losses:

$$P_1 = 202.4705 \text{ MW}$$

$$P_2 = 80.9842 \text{ MW}$$

$$P_3 = 27.0818 \text{ MW}$$

Power Loss = 10.5362 MW

Total generation cost = 3615.10 Rs/h

Result through PSO method with transmission loss:

The following PSO parameters are considered

Population size = 100

Inertia weight factor  $\omega$ ,  $\omega_{max} = 0.9$  and  $\omega_{min} = 0.4$

Acceleration constant  $C_1 = 2$  &  $C_2 = 2$

$$V_{pd}^{max} = 0.5 P_d^{max}, V_{pd}^{min} = -0.5 P_d^{min}$$

The result as follows

$$P_1 = 202.1842 \text{ MW}$$

$$P_2 = 80.6101 \text{ MW}$$

$$P_3 = 27.7972 \text{ MW}$$

Power Loss = 10.5915 MW

Total generation cost = 3615.10 Rs/h

In this figure, fuel cost is converged at cost of 3615.10 Rs/h. Here transmission losses are 10.5362 MW. There are 100 numbers of iteration is taken.

Fuel Cost and Power Loss Comparison

Table 5: Fuel Cost and power loss Comparison

Name	Fuel Cost	Power Loss
PSO method	3615.10 Rs/h	10.5363 MW
GA Method	3615.10 Rs/h	10.5362 MW
ALO Method	3615.10 Rs/h	10.5915 MW

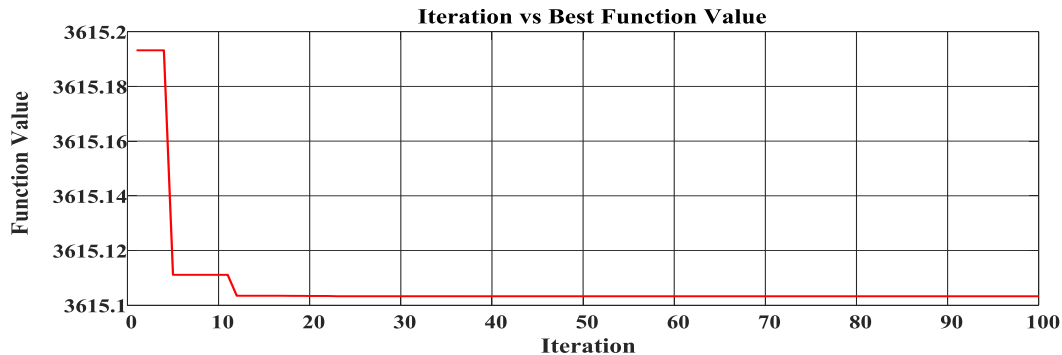

Fig 7: Fuel cost curve with transmission losses

CASE STUDY- 2: Six Unit System

The fuel cost in Rs./h of three plants of a power system are

$$C_1 = 240 + 7p_1 + 0.007p_1^2 \text{ Rs./h}$$

$$C_2 = 200 + 10p_2 + 0.0095p_2^2 \text{ Rs./h}$$

$$C_3 = 220 + 8.5p_3 + 0.009p_3^2 \text{ Rs./h}$$

$$C_4 = 200 + 11p_4 + 0.009p_4^2 \text{ Rs./h}$$

$$C_5 = 220 + 10.5p_5 + 0.008p_5^2 \text{ Rs./h}$$

$$C_6 = 190 + 12p_6 + 0.0075p_6^2 \text{ Rs./h}$$

Where P1, P2, P3, P4, P5 and P6 are in MW. Plants outputs are subject to the following limits

$$100\text{MW} \leq P1 \leq 500 \text{ MW}$$

$$50\text{MW} \leq P2 \leq 200 \text{ MW}$$

$$80\text{MW} \leq P3 \leq 300 \text{ MW}$$

$$50\text{MW} \leq P4 \leq 150 \text{ MW}$$

$$50\text{MW} \leq P5 \leq 200 \text{ MW}$$

$$50\text{MW} \leq P6 \leq 120 \text{ MW}$$

Total system load is 700MW

Load demand is varied from 700 MW to 1410 MW, as the maximum load for the system can be 1470 as per total generation capacity. The variation of ELD will be observed by implementing ALO, GA and PSO techniques. Fuel cost and power loss is calculated for the system and observed by the means of comparative graphs.

ED WITH TRANSMISSION LINE LOSSES

Result through Ant lion Optimization method with transmission losses:

Table.6. ELD using ALO method

S.no	Load Demand (MW)	P1(MW)	P2(MW)	P3(MW)	P4(MW)	P5(MW)	P6(MW)	Power Loss (MW)	Fuel Cost (Rs/h)
1	700	323.6372 955	76.68567 444	158.4358 995	50	51.97655 08	50	10.735420 17	8352.61 0918
2	800	355.9937 477	99.38828 304	181.7274 753	50	77.22789 24	50	14.337398 44	9558.56 4662
3	900	383.3434 166	118.5722 287	201.3606 69	67.09888 939	98.12433 645	50	18.499540 2	10812.5 2698
4	1000	410.3963 375	137.5002 613	220.7039 593	86.04175 313	118.5963 652	50	23.238676 49	12110.3 5945
5	1200	459.2240 008	171.5733 061	255.4934 874	119.8293 623	154.7213 829	73.76875 841	34.610297 87	14834.8 2775
6	1400	499.9999 966	200	292.2256 642	150	192.9166 463	113.7236 97	48.866004 11	17720.0 2255
7	1410	499.9999 97	200	295.4717 246	149.9999 944	195.9408 271	118.3482 725	49.760815 57	17869.4 8631

The analysis of table 6 shows that at 700 MW load, power loss is 10.74 MW and at 1410 MW it is 49.76 MW, whereas the variation in load demand from 700 to 1410 MW and fuel cost vary from 8352.61 Rs/h to 17869.5 Rs/h. the power distribution of six generators from P1 to P6 are also presented. Result through GA method with transmission losses:

Table.7. ELD using GA method

S.no	Load Demand (MW)	P1(MW)	P2(MW)	P3(MW)	P4(MW)	P5(MW)	P6(MW)	Power Loss (MW)	Fuel Cost (Rs/h)
1	700	323.6372 955	76.68567 444	158.4358 995	50	51.97655 08	50	10.73542017	8352.610918
2	800	355.9937 477	99.38828 304	181.7274 753	50	77.22789 24	50	14.33739844	9558.564662
3	900	383.3434 166	118.5722 287	201.3606 69	67.09888 939	98.12433 645	50	18.4995402	10812.52698
4	1000	410.3963 375	137.5002 613	220.7039 593	86.04175 313	118.5963 652	50	23.23867649	12110.35945
5	1200	459.2240 008	171.5733 061	255.4934 874	119.8293 623	154.7213 829	73.76 87584 1	34.61029787	14834.82775
6	1400	499.9961 188	200	291.1855 245	150	194.0744 04	113.6 24935 3	48.88098263	17720.02139
7	1410	499.9906 975	200	297.3862 913	150	194.9720 836	117.3 95626	49.74469839	17869.63243

The analysis of table 7 shows that at 700 MW load, power loss is 10.74 MW and at 1410 MW it is 49.75 Mw, whereas the variation in load demand from 700 to 1410 MW and fuel cost vary from 8352.61 Rs/h to 17869.6 Rs/h. the power distribution of six generators from P1 to P6 are also presented. Result through PSO method with transmission loss: The following PSO parameters are considered

Population size = 100

Inertia weight factor  $\omega$ ,  $\omega_{max} = 0.9$  and  $\omega_{min} = 0.4$

Acceleration constant  $C_1 = 2$  &  $C_2 = 2$

$$V_{pd}^{max} = 0.5 P_d^{max}, V_{pd}^{min} = -0.5 P_d^{min}$$

The result as follows

Table.8. ELD using PSO method

S.no	Load Demand (MW)	P1(MW)	P2(MW)	P3(MW)	P4(MW)	P5(MW)	P6(MW)	Power Loss (MW)	Fuel Cost (Rs/h)
1	700	323.4040 684	76.74709 502	158.372 3205	50	52.21547 382	50	10.7389577 9	8352.61185
2	800	355.8934 794	99.68384 243	181.338 1487	50	77.42139 116	50	14.3368617 6	9558.56737 5
3	900	383.6180 912	118.5618 823	201.171 7485	67.1524 0146	97.98906 298	50	18.4931864 9	10812.5280 9
4	1000	409.5418 675	137.6610 766	220.879 5876	86.4435 3548	118.7278 507	50	23.2539179 9	12110.3667 9
5	1200	459.3485 515	171.5160 058	255.389 902	119.553 0297	154.9951 497	73.80 90101 2	34.6116487 6	14834.8293 9

6	1400	500	200	292.282 3437	150	192.5554 992	114.0 24567 2	48.8624100 8	17720.0211 6
7	1410	500	199.9999 999	295.639 7551	149.999 9928	196.3660 208	117.7 58279	49.7640475 9	17869.4856 7

The analysis of table 8 shows that at 700 MW load, power loss is 10.74 MW and at 1410 MW it is 49.76 Mw, whereas the variation in load demand from 700 to 1410 MW and fuel cost vary from 8352.61 Rs/h to 17869.5 Rs/h. the power distribution of six generators from P1 to P6 are also presented. Cost comparison

Table 9: Cost comparison of ALO, GA and PSO method with transmission loss

Load Demand (MW)	ALO Fuel Cost (Rs/h)	GA Fuel Cost (Rs/h)	PSO Fuel Cost (Rs/h)
700	8352.610918	8352.610918	8352.61185
800	9558.564662	9558.564662	9558.567375
900	10812.52698	10812.52698	10812.52809
1000	12110.35945	12110.35945	12110.36679
1200	14834.82775	14834.82775	14834.82939
1400	17720.02255	17720.02139	17720.02116
1410	17869.48631	17869.63243	17869.48567

Table 10: Power Loss comparison of ALO, GA and PSO method with transmission loss

Load Demand (MW)	ALO-Power Loss (MW)	GA-Power Loss (MW)	PSO-Power Loss (MW)
700	10.73542017	10.73542017	10.73895779
800	14.33739844	14.33739844	14.33686176
900	18.4995402	18.4995402	18.4931864
1000	23.23867649	23.23867649	23.2539179
1200	34.61029787	34.61029787	34.61164876
1400	48.86600411	48.88098263	48.86241008
1410	49.76081557	49.74469839	49.76404759

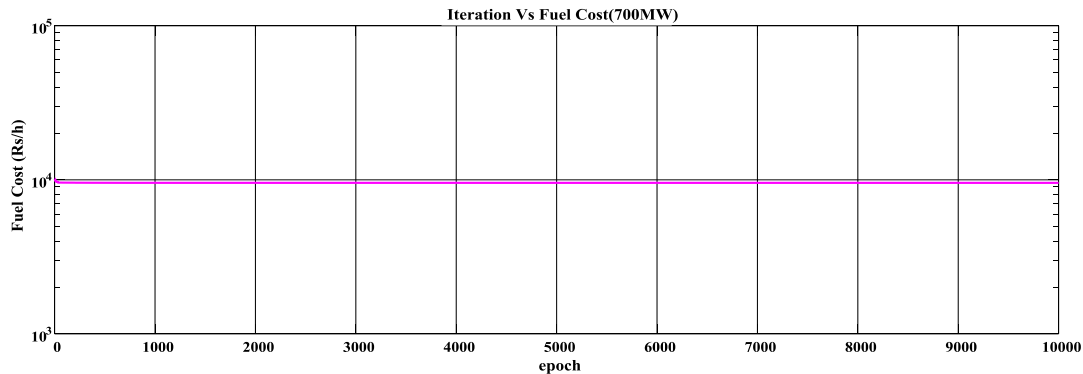

Fig 8: Fuel cost curve for load demand 700MW with transmission loss

In this figure, fuel cost is converged at 8352.61185 Rs/h for 700 MW power demand. Here transmission losses are 10.739 MW. There are 10000 numbers of iteration is taken.

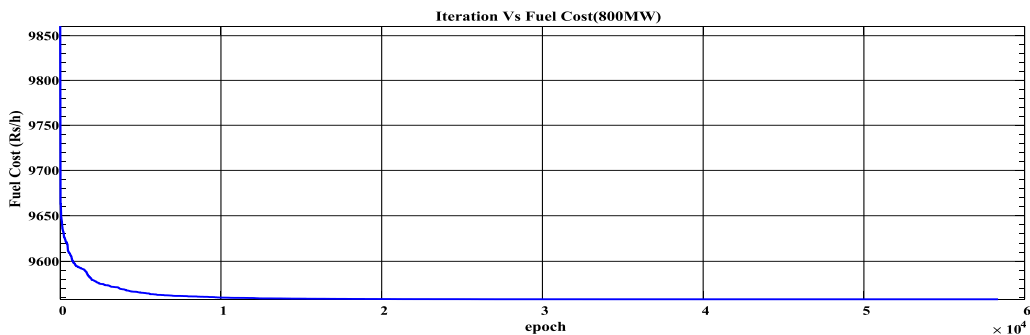

Fig 9: Fuel cost curve for load demand 800MW with transmission loss

In this figure, fuel cost is converged at 9558.567375 Rs/h for 800 MW power demand. Here transmission losses are 14.33686176 MW. There are 10000 numbers of iteration is taken.

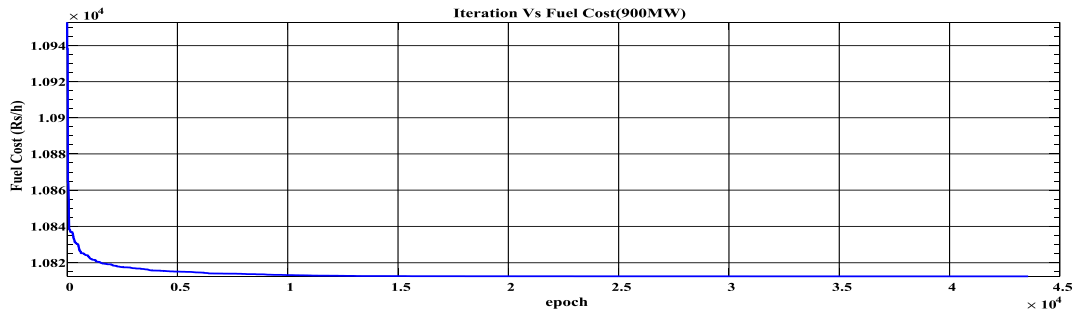

Fig 10: Fuel cost curve for load .demand 900MW with transmission loss

In this figure, fuel cost is converged at 10812.52809 Rs/h for 900 MW power demand. Here transmission losses are 18.4931864 MW. There are 10000 numbers of iteration is taken.

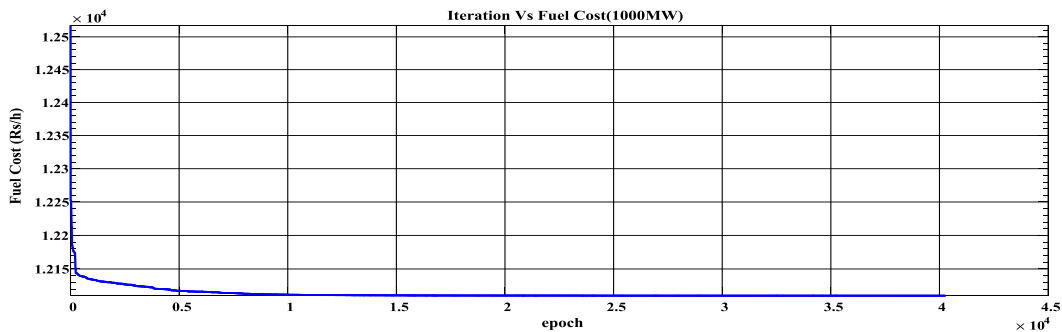

Fig 11: Fuel cost curve for load dem.and 1000MW with transmission loss

In this figure, fuel cost is converged at 12110.36679 Rs/h for 1000 MW power demand. Here transmission losses are 23.2539179MW. There are 10000 numbers of iteration is taken.

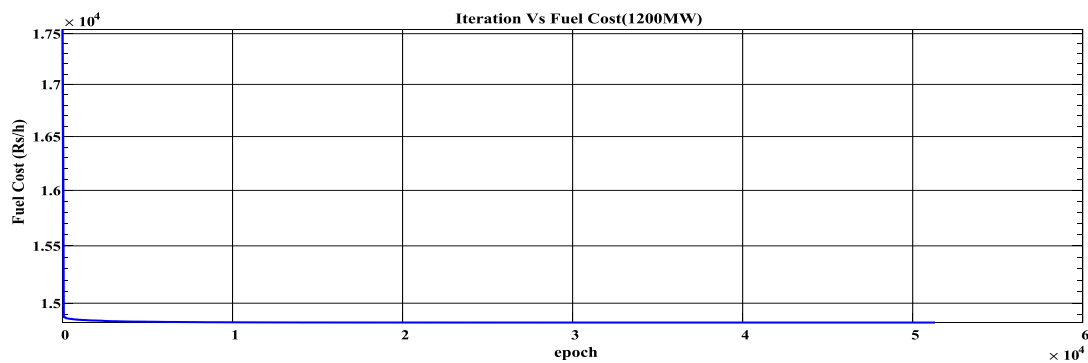

Fig 12: Fuel cost curve for load demand 1200MW with transmission loss

In this figure, fuel cost is converged at 14834.82939 Rs/h for 1200 MW power demand. Here transmission losses are 34.61164876 MW. There are 10000 numbers of iteration is taken.

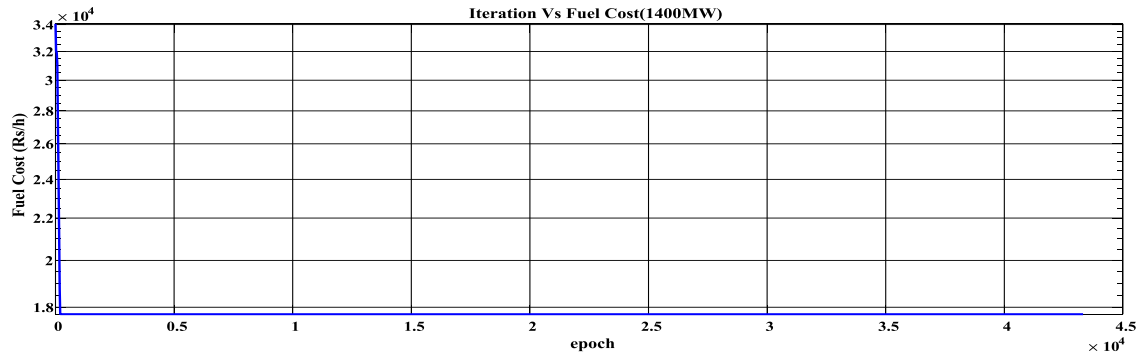

Fig 13: Fuel cost curve for load demand 1400MW with transmission loss

In this figure, fuel cost is converged at 17720.02116 Rs/h for 1400 MW power demand. Here transmission losses are 48.86241008 MW. There are 10000 numbers of iteration is taken.

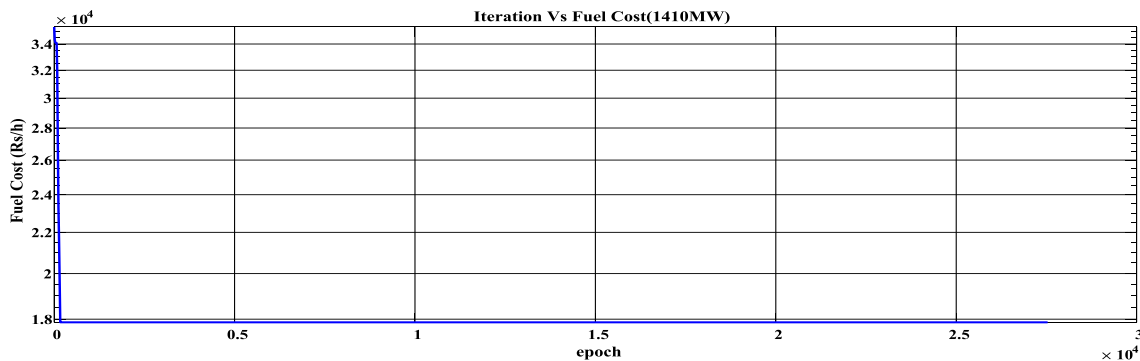

Fig 14: Fuel cost curve for load demand 1410MW with transmission loss

In this figure, fuel cost is converged at 17869.48567 Rs/h for 1410 MW power demand. Here transmission losses are 49.76404759 MW. There are 10000 numbers of iteration is taken.

As per the load demand in the six generator IEEE system varies from 700Mw to 1410 MW the fuel cost also varies by various optimization techniques implemented on system. This variation of fuel cost is presented for various load demands. It is observed from this graph that there is minor variation in cost while using ALO, Ga and PSO when the load is not at its maximum capacity loading. Fuel cost is measured in Rs/ hr.

Similarly, the power loss is also measured for the same system at same condition that is presented in figure 15. In this factor, there is variation in watt quantity as the unit considered is MW in system. Variation that is observed in different techniques is of 10-20 watt only.

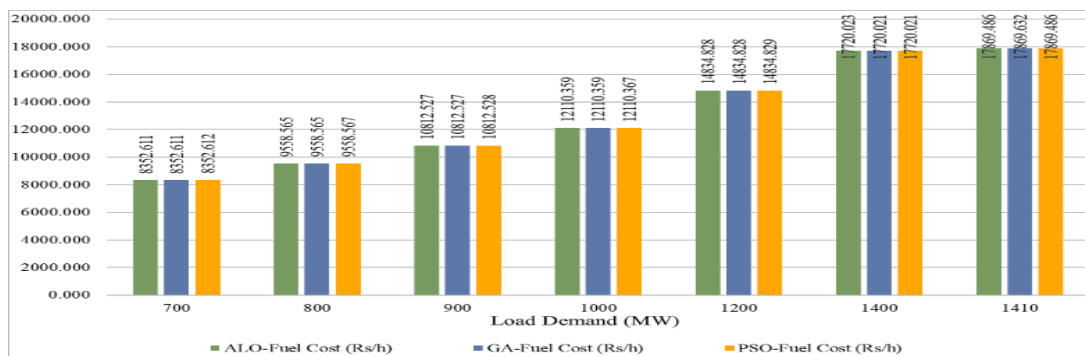

Fig.15 Fuel Cost graph for load demand

### V. Conclusion

In this thesis, a comparative analysis has been proposed to solve the multi-purpose optimization and electrical impairment problem by using hybrid made from particle swarm optimization, genetic algorithms and ant lion optimization. By confirming this method using the 3-generator testing system and the IEEE 6-generator

testing system, and comparing the results obtained from other optimization methods, the efficiency of the proposed method in addressing the multi-objective problem.

Variation of power demand and different types of test system levels was done to show that the proposed optimization method is a stable behavior independent of the size of the system, which is not limited to local optima and is not a feasible solution.

The PSO method was actually capable to achieve high quality solutions for ELD problems. Convergence is good because some numbers move in the algorithm, therefore less calculation time is reduced. Light loss and fuel costs are celebrated to vary linearly according to the demand for load. The reliability of algorithms is extremely reliable for the various runs of the program, which means that despite the execution of the program, it is capable of achieving similar results for the problem. Thus, PSO is an effective method of solving economic load dispatch problem because it works with progressive improvements and has the advantage of integrating it at its global point of view. Convergence of a global point is cost savings and therefore the maximum profit algorithm is relatively simple, reliable and efficient therefore it is suitable for practical applications.

Genetic algorithm and ALO are used to solve economic dispatch problems for thermal units with different systems. Genetic algorithm and ALO are a simple but powerful Stochastic Global Optimizer. As a result of simulation, we have examined that the algorithm (GA) with the Lambda search method effectively works to solve the ELD problem of electrical systems with different numbers. Production units are able to calculate various parameters like electricity distribution, incremental fuel cost, simulation, error, time required for power loss.

The 3-generator was subjected to 300 MW levels of electricity demand. Cardinal Priority Ranking Method and classical weighted amount was estimated for various loading levels with the help of economic dispatch emission transmission and combined economic and emission transmission. The GA had performed very well in the emission dispatch phase and had comparative results with Economic dispatch during assessment against PSO and ALO.

The 6 generator testing system was subject to 700 MW, 800 MW, 900 MW, 1000 MW, 1200 MW, 1400 MW and 1410 MW of power demand. Using the classical weighted amount and cardinal priority ranking method, economic remittance, emission dispatch for different loading levels was estimated, PSO did well in the emission dispatch phase compared with GA and ALO. This was a comparative result in the economic dispatch phase. Although this method shows some weakness in terms of high computational time, more research areas have also been proposed.

## Reference

- [1]. M. A. Algabalawy, A. Y. Abdelaziz, S. F. Mekhamer and M. A. L. Badr, "Optimal multi-criteria design of a new hybrid power generation system using ant lion and grey wolf optimizers," 2016 Eighteenth International Middle East Power Systems Conference (MEPCON), Cairo, 2016, pp. 138-146.
- [2]. R. Babers, N. I. Ghali, A. E. Hassanien and N. M. Madbouly, "Optimal community detection approach based on Ant Lion Optimization," 2015 11th International Computer Engineering Conference (ICENCO), Cairo, 2015, pp. 284-289.
- [3]. N. Chopra and S. Mehta, "Multi-objective optimum generation scheduling using Ant Lion Optimization," 2015 Annual IEEE India Conference (INDICON), New Delhi, 2015, pp. 1-6.
- [4]. S. Gupta, V. Kumar, K. P. S. Rana, P. Mishra and J. Kumar, "Development of Ant Lion Optimizer toolkit in LabVIEW™," 2016 International Conference on Innovation and Challenges in Cyber Security (ICICCS-INBUSH), Noida, 2016, pp. 251-256.
- [5]. E. S. Prasad and B. V. S. Ram, "Ant-lion optimizer algorithm based FOPID controller for speed control and torque ripple minimization of SRM drive system," 2016 International Conference on Signal Processing, Communication, Power and Embedded System (SCOPEs), Paralakhemundi, 2016, pp. 1550-1557.
- [6]. I.N. Trivedi, S. A. Parmar, R. H. Bhesdadiya and P. Jangir, "Voltage stability enhancement and Voltage Deviation Minimization using ant-lion optimizer algorithm," 2016 2nd International Conference on Advances in Electrical, Electronics, Information, Communication and Bio-Informatics (AEEICB), Chennai, 2016, pp. 263-267.
- [7]. E. Umamaheswari, S. Ganesan, M. Abirami and S. Subramanian, "Deterministic reliability model based preventive generator maintenance scheduling using Ant Lion Optimizer," 2016 International Conference on Circuit, Power and Computing Technologies (ICCPCT), Nagercoil, 2016, pp. 1-8.
- [8]. S. Verma and V. Mukherjee, "Optimal real power rescheduling of generators for congestion management using a novel ant lion optimizer," in IET Generation, Transmission & Distribution, vol. 10, no. 10, pp. 2548-2561, 7 7 2016.
- [9]. W. Yamany, A. Tharwat, M. F. Hassanin, T. Gaber, A. E. Hassanien and T. H. Kim, "A New Multi-layer Perceptrons Trainer Based on Ant Lion Optimization Algorithm," 2015 Fourth International Conference on Information Science and Industrial Applications (ISI), Busan, 2015, pp. 40-45.
- [10]. Guo-Li Zhang, Hai-Yan Lu, Geng-Yin Li and Guang-Quan Zhang, "Dynamic economic load dispatch using hybrid genetic algorithm and the method of fuzzy number ranking," 2005 International Conference on Machine Learning and Cybernetics, Guangzhou, China, 2005, pp. 2472-2477 Vol. 4.
- [11]. K. Asano, M. Nakatsuka and T. Kumano, "Dynamic Economic Load Dispatch by Calculus of Variation and Genetic Algorithm Considering Ramp Rate," 2009 15th International Conference on Intelligent System Applications to Power Systems, Curitiba, 2009, pp. 1-6.
- [12]. C. L. Chiang, "Genetic-based algorithm for power economic load dispatch," in IET Generation, Transmission & Distribution, vol. 1, no. 2, pp. 261-269, March 2007.
- [13]. A. Derghal and N. Golea, "Genetic algorithm for solving large practical fuzzy economic load dispatch with prohibited operating zones," 2014 International Renewable and Sustainable Energy Conference (IRSEC), Ouarzazate, 2014, pp. 469-474.

- [14]. F. K. Khosa, M. F. Zia and A. A. Bhatti, "Genetic algorithm based optimization of economic load dispatch constrained by stochastic wind power," 2015 International Conference on Open Source Systems & Technologies (ICOSST), Lahore, 2015, pp. 36-40.
- [15]. R. Lingala, A. Bethina, P. V. R. Rao and K. Sumanth, "Economic load dispatch using heuristic algorithms," 2015 IEEE International Conference on Electrical and Computer Engineering (WIECON-ECE), Dhaka, 2015, pp. 519-522.
- [16]. H. d. Liu, Z. I. Ma, S. Liu and H. Lan, "A New Solution to Economic Emission Load Dispatch Using Immune Genetic Algorithm," 2006 IEEE Conference on Cybernetics and Intelligent Systems, Bangkok, 2006, pp. 1-6.
- [17]. K. B. Sahay, N. Kumar and M. M. Tripathi, "Implementation of different optimization techniques to solve ELD problem," 2014 6th IEEE Power India International Conference (PIICON), Delhi, 2014, pp. 1-6.
- [18]. M. Sevil, O. Ayan and B. Turkay, "Economic and environmental load dispatch using genetic algorithm," 2017 2nd International Conference Sustainable and Renewable Energy Engineering (ICSREE), Hiroshima, 2017, pp. 53-57.
- [19]. U. Sharma and B. Moses, "Analysis and optimization of economic load dispatch using soft computing techniques," 2016 International Conference on Electrical, Electronics, and Optimization Techniques (ICEEOT), Chennai, 2016, pp. 4035-4040.
- [20]. Warsono, D. J. King, C. S. Ozveren and D. A. Bradley, "Economic Load Dispatch Optimization of Renewable Energy in Power System Using Genetic Algorithm," 2007 IEEE Lausanne Power Tech, Lausanne, 2007, pp. 2174-2179.
- [21]. W. Warsono, C. S. Ozveren, D. J. King and D. Bradley, "A review of the use of genetic algorithms in economic load dispatch," 2008 43rd International Universities Power Engineering Conference, Padova, 2008, pp. 1-5.
- [22]. J. David Gomez, L. F. Gaitan and E. R. Trujillo, "Particle swarm optimization applied to economic dispatchs," 2017 IEEE Workshop on Power Electronics and Power Quality Applications (PEPQA), Bogota, 2017, pp. 1-5.
- [23]. M. N. Alam, A. Mathur and K. Kumar, "Economic load dispatch using a differential particle swarm optimization," 2016 IEEE 1st International Conference on Power Electronics, Intelligent Control and Energy Systems (ICPEICES), Delhi, 2016, pp. 1-5.
- [24]. F. Benhamida, Y. Salhi, I. Ziane, S. Souag, R. Belhachem and A. Bendaoud, "A PSO algorithm for the economic load dispatch including a renewable wind energy," 3rd International Conference on Systems and Control, Algiers, 2013, pp. 1104-1109.
- [25]. H. Cao et al., "Economic dispatch of micro-grid based on improved particle-swarm optimization algorithm," 2016 North American Power Symposium (NAPS), Denver, CO, 2016, pp. 1-6.
- [26]. B. Das and T. K. Sengupta, "Economic load dispatch using PSO and TLBO," Michael Faraday IET International Summit 2015, Kolkata, 2015, pp. 212-219.
- [27]. D. Maity, S. Banejee, C. K. Chanda and S. Samanta, "Implementation of MRPSO techniques on economic load dispatch problem considering various generator constraints," 2016 10th International Conference on Intelligent Systems and Control (ISCO), Coimbatore, 2016, pp. 1-6.
- [28]. S. B. Nejad, S. H. Elyas, A. Khamseh, I. N. Moghaddam and M. Karrari, "Hybrid CLONAL selection algorithm with PSO for valve-point Economic load Dispatch," 2012 16th IEEE Mediterranean Electrotechnical Conference, YasmineHammamet, 2012, pp. 1147-1150.
- [29]. D. Santra, A. Mukherjee, K. Sarker and D. Chatterjee, "Hybrid PSO-ACO algorithm to solve economic load dispatch problem with transmission loss for small scale power system," 2016 International Conference on Intelligent Control Power and Instrumentation (ICICPI), Kolkata, 2016, pp. 226-230.

IOSR Journal of Electrical and Electronics Engineering (IOSR-JEEE) is UGC approved Journal with Sl. No. 4198, Journal no. 45125.

Saiyadasad Ali Naqvi "Optimization in Load Flow Analysis of Power System Interconnected System Using Sponge and Aloe Techniques." IOSR Journal of Electrical and Electronics Engineering (IOSR-JEEE) 13.3 (2018): 27-42.